

RIPTIDE



TABLE OF CONTENTS

Introduction.....	1
Isometric Images.....	2
Riptide™ Diffusers.....	2
Ancillary/Service Components.....	3
Assembly.....	7
General Assembly.....	7
Field Ops.....	8
General Use.....	8
Stacking Configurations.....	9
Waterway Configurations.....	10
Reduced Orifice Insert Configurations.....	10
Typhoon Remote Manifold.....	11
Service.....	12
Replacing the Pitot.....	12
Replacing the Coupling.....	14
Replacing the Receiver <i>(ALX Models Only)</i>	14
Replacing the Pin Lock <i>(ALX Models Only)</i>	14
Replacing the Cleats <i>(ALX Models Only)</i>	14
Disclaimer.....	17
Authorized Stacking Configurations.....	18
Authorized Waterway Configurations.....	19
Authorized Reduced Orifice Configurations.....	20
Single Action Orifice Chart.....	20
Double Action Orifice Chart.....	20
Triple Action Orifice Chart.....	20
Quad Action Orifice Chart.....	21
LDH 4” Orifice Chart.....	21
Single/LDH 4” Orifice Chart.....	21
Single/Double Action Orifice Chart.....	22
Single/Triple Action Orifice Chart.....	22
Single/Quad Action Orifice Chart.....	22
Double/LDH 4” Orifice Chart.....	23
Double/Triple Action Orifice Chart.....	23
Double/Quad Action Orifice Chart.....	23
Triple/LDH 4” Orifice Chart.....	24
Triple/Quad Action Orifice Chart.....	24
LDH 4”/Quad Action Orifice Chart.....	24
Riptide™ Pitot Charts.....	25

INTRODUCTION

FIRE PUMP FLOW TESTING EQUIPMENT UNIT EX29051 THE RIPTIDE FLOW TESTING SYSTEM



AS TO FLOW MEASUREMENT ACCURACY SPECIFIED BY THE MANUFACTURER WHEN INSTALLED IN ACCORDANCE WITH THE MANUFACTURERS INSTALLATION INSTRUCTIONS

Performance of The Riptide Flow Testing System™ and The Riptide Flow Testing System ALX™ requires proper assembly, use, service, adhering to approved Stacking Configurations and Waterway Configurations, proper Reduced Orifice Insert Configurations, utilizing the appropriate firehose diameter, as well as storage when not in use. UL Classification Mark applies to the Hose Coupling, Waterway, Reduced Orifice Inserts, Pitot Tubes, and Diffuser Box assembly. Accuracy claims may be impacted by any fittings, connections, and gauges downstream of the Pitot threads. Branded and calibrated Riptide™ gauges are optimal for accuracy and ergonomic comfort due to their 3 o'clock and 9 o'clock connection orientations. Correlating volumes for a given orifice size can be found on the factory Pitot chart. OSHA required PPE should be worn at all times.

FIRE PUMP FLOW TESTING EQUIPMENT UNIT EX29051 THE RIPTIDE FLOW TESTING SYSTEM ALX



AS TO FLOW MEASUREMENT ACCURACY SPECIFIED BY THE MANUFACTURER WHEN INSTALLED IN ACCORDANCE WITH THE MANUFACTURERS INSTALLATION INSTRUCTIONS

ISOMETRIC IMAGES

SINGLE ACTION
RIPTIDE™



DOUBLE ACTION
RIPTIDE™



TRIPLE ACTION
RIPTIDE™



QUAD ACTION
RIPTIDE™



LDH 4"
RIPTIDE™



**LDH 4"
JET STREAM**



**2.50" JET STREAM
WITH CASE**



**TYPHOON
REMOTE MANIFOLD**



**1.125" REDUCED
ORIFICE INSERT**



**1.750" REDUCED
ORIFICE INSERT**



**3.250" REDUCED
ORIFICE INSERT**



RIPTIDE DECHLOR



**2.50" PITOT
ALIGNMENT TOOL**



**LDH 4" PITOT
ALIGNMENT TOOL**



**2.50" RIPTIDE
PITOT**



**4" RIPTIDE
PITOT**



**2.50" RIPTIDE
ALX PITOT**



**4" RIPTIDE
ALX PITOT**



2.50" COUPLING



4" COUPLING



**RIPTIDE
LEVELING TABLE**



**+/-1% ACCURACY
9 O'CLOCK GAUGE**



**+/-1% ACCURACY
3 O'CLOCK GAUGE**



**RIPTIDE
RUBBER FOOT KIT**



**RIPTIDE
SPANNER WRENCH**



**TYPHOON
VELCRO STRAPS**



**0.25" QUICK
CONNECT ASSEMBLY**



0.25" STREET 90°

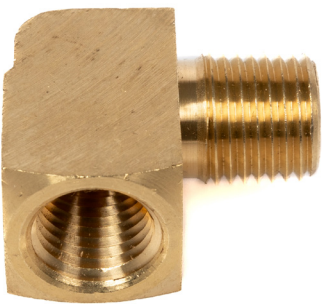

**TYPHOON 0.25"
BALL VALVE**



**TYPHOON 0.25"
PUSH CONNECT**

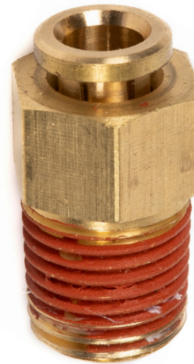

CAM-LOCK KIT



ASSEMBLY

GENERAL ASSEMBLY

Each Riptide™ Diffuser comes with the following loose items:

- | | |
|-------------------------|---|
| ☐ 26 Machine Screws | ☐ 4 Cam-Locks |
| ☐ 26 Nylon Locking Nuts | ☐ 4 Hooks |
| ☐ 26 Washers | ☐ 1 Quick Connect Assembly per Waterway |
| ☐ 10 Rubber Feet | ☐ 1 Street 90° per Waterway |

Step 1. Insert one Machine Screw through the bottom of each of the Rubber Feet. The bottom has an indentation with a visible integral metal washer.

Step 2. Insert the Rubber Foot/Machine Screw combination through any of the holes on the bottom of The Riptide™.

Step 3. Within the Diffusing Box where the Machine Screw now protrudes, apply a Washer and Nylon Locking Nut, then tighten with a Phillips screwdriver and an 11/32" box wrench by turning clockwise until snug. Repeat for all of the holes on the bottom of The Riptide™. Do not over tighten.

Step 4. Insert one Machine Screw through each of the two holes on the Hooks and insert them into the holes towards the bottom of The Riptide™. The back of the Hooks should sit flush against the body of the Diffusing Box with the Cam-Lock Eyelet Seat of the Hooks closest to the bottom of The Riptide™, and oriented out.

Step 5. Within the Diffusing Box where the Machine Screws now protrude, apply a Washer and Nylon Locking Nut to each, then tighten with a Phillips screwdriver and an 11/32" box wrench by turning clockwise. Repeat for all of the holes towards the bottom of The Riptide™. Tighten to 30lb. in. of torque.

Step 6. Insert one Machine Screw through each of the two holes on the Cam-Locks and insert them into the holes towards the top of The Riptide™. The back of each should sit flush against the body of the Diffusing Box with the buckle portion oriented out and the arrow on the Locking Spring Loaded Red Safety Tabs pointing down.

Step 7. Within the Diffusing Box where the Machine Screws now protrude, apply a Washer and Nylon Locking Nut to each, then tighten with a Phillips screwdriver and an 11/32" box wrench by turning clockwise. Repeat for all of the holes towards the top of The Riptide™. Tighten to 30lb. in. of torque.

Step 8. Apply Teflon tape to the male NPT end of the Quick Connect Plug and thread into the female end of the Street 90°, turning clockwise until hand tight.

Step 9. Using an 11/16" box wrench as a holdback on the Street 90°, tighten the Quick Connect Plug with an additional 9/16" box wrench by turning clockwise, until liquid tight or 90lb. in. of torque.

Step 10. Apply teflon tape to the male NPT end of the Street 90° and thread into the female NPT outlet on the Pitot, turning clockwise until hand tight.

Riptide ALX Addendum: In addition to the requirements noted above and throughout this User Guide, in situations where there's a Receiver above a given Waterway, it must be removed from the Receiver to create the space needed to install the Street 90°.

Step 11. Using an 11/16” box wrench as a holdback on the Pitot hex, tighten the Street 90° by turning clockwise with an additional 11/16” box wrench until liquid tight or 90lb. in. of torque. The female end of the Street 90° should be indexed perpendicular to the Waterway it has been installed upon. On Triple and Quad Action Riptides™, the 90°s should directionally oppose one another. Ensure that the orientation of the Pitot is still correct after installation of the Street 90°.

Step 12. Apply teflon tape to the male NPT end on The Riptide™ branded gauge and thread into the female NPT end of the Quick Connect by turning clockwise until hand tight.

Step 13. Using a 3/4” box wrench as a holdback on the Quick Connect, tighten The Riptide™ branded gauge with an additional 5/8” box wrench by turning clockwise until liquid tight or 90lb. in. of torque.

Step 14. Securely connect the female end of the Quick Connect to the male end of the Quick Connect Plug in the Street 90° referenced above.

Step 15. Repeat Steps 8-14 if there are multiple Waterways.

FIELD OPS

GENERAL USE

Step 1. Evaluate the condition of the equipment. Observe the Rubber Feet, Coupling gasket(s), Pitot Orientation(s), Cam-Locks, Hooks, Nylon Locking Nuts, Machine Screws, etc. Fix, replace or calibrate any component found to be deficient, prior to use. If stacking is uncommon, it is acceptable to remove and store the Cam-Locks and Hooks in a safe place. Nylon Locking Nuts/Machine Screws/Washers should be left in place on The Riptide™ Core as retainers. All relevant instructions under Assembly, Field Ops, Service, Authorized Stacking Configurations, Authorized Waterway Configurations and Authorized Reduced Orifice Insert Configurations apply.

Riptide ALX Addendum: In addition to the requirements noted above and throughout this User Guide, evaluate the condition of the Pin Lock(s), Receiver(s), Receiver Cleats and Cleat Channels on the Waterway(s).

Step 2. Connect/thread the female end of a 2.50” diameter firehose to the source being tested, or 4” for the LDH 4”. Repeat this step if a plurality of Waterways will be used.

Riptide ALX Addendum: In addition to the requirements noted above and throughout this User Guide, if desired the Waterway(s) can be removed from the Receiver(s) for the purposes of flowing to atmosphere without diffusing. To remove - depress the Red Safety Button on the Pin Lock and pull the Black Knob away from the Waterway. Twist the Waterway counterclockwise until it stops, then slide it out of the Receiver by pulling it away from the Diffusing Box. Do not flow water from a Waterway that is attached directly to a firehose, yet not in a Receiver affixed to a Riptide Diffuser. Do not remove a Waterway from a Receiver while actively flowing water.

Step 3. Place The Riptide™ Diffuser on a flat surface and connect/thread the same 2.50” firehose, or 4” for the LDH 4”, referenced above into the Coupling on The Riptide™. Do not over tighten or excessively compress internal gaskets. Repeat this step if a plurality of Waterways will be used.

Step 4. Using the provided Street 90°/Quick Connect configuration, attach the gauge to the Pitot built into the Waterway. Repeat this step if a plurality of Waterways will be used. Connections should be water tight.

Step 5. Straighten the firehose referenced above, removing twists and kinks.

Step 6. Make observations regarding potential situational hazards that may impede the ability to flow water. It is strongly recommended that high visibility traffic cones, barriers, caution tape, etc. are used to aid in securing the work area.

Step 7. Slowly open the source being tested so as to introduce water into the 2.50"/4" firehose referenced above until it reaches The Riptide™ Diffuser. Having observed discharge, continue to open the source to a satisfactory point. The recommended discharge per 2.50" Waterway is 500 GPM. For each additional 500 GPM, another Waterway should be used.

Step 8. Approach The Riptide™ Diffuser adjacent to the path of the firehose and observe the gauge(s). Take note of the reading(s) and reference The Riptide™ factory Pitot chart to determine the volume flowing. If flushing only, this step is not required.

Step 9. After flow rates have been achieved, very slowly begin to close the source being tested. It is vital that the source is closed in a predictable, controlled manner without haste or aggressive turns to avoid potential source damage.

Step 10. Post flow, disconnect the firehose from The Riptide™. Dry it off and if desired, wipe down the interior of the Waterway(s) with a rag and Blaster Surface Shield Rust Protectant. Store in a safe, secure place for future use.

Riptide ALX Addendum: In addition to the requirements noted above and throughout this User Guide, if the Waterway(s) has/ have been removed for the purposes of flowing to atmosphere, slide them back in the Receiver(s). To install - depress the Red Safety Button on the Pin Lock and pull the Black Knob away from the Waterway. Slide the Waterway into the Receiver with the Pitot pointing up so that it is roughly aligned with the Receiver Cove at the 11 o'clock position. Gently oscillate the Waterway until the Cleat Channels are aligned with the Cleats, then push the Waterway into place until it wont go any further. Now turn the Waterway clockwise until it stops. The Pitot should be pointing straight up at the 12 o'clock position within the Receiver Cove and the Pin Lock should be engaged in the pin cavity on the side of the Waterway so that rotation of the Waterway is not possible. The Red Safety Button on the Pin Lock should also be engaged so that the Black Knob cannot be pulled away from the Waterway. Do not install a Waterway while actively flowing water.

Step 11. Return the work area to the state it was found in upon arrival. Do not leave tools or equipment behind.

STACKING CONFIGURATIONS

Step 1. Factory Authorized Stacking Configurations include up to (3) Single Action Riptides™ or (2) of any other combination of Riptide™ Diffusers. Please refer to the factory provided spreadsheets on page 11 for Authorized Stacking Configurations. Only factory Authorized Stacking Configurations are permitted. All relevant instructions under Assembly, Field Ops, Service, Authorized Stacking Configurations, Authorized Waterway Configurations and Authorized Reduced Orifice Insert Configurations apply.

Riptide ALX Addendum: In addition to the requirements noted above and throughout this User Guide, Riptide ALX may never be placed underneath a legacy steel Riptide when stacking.

Step 2. When stacking, place the bottom most (First Tier) Riptide™ on a flat surface. Then place the subsequent Riptide™ (Second Tier) on top of the First Tier. Swing all Cam-Lock Eyelets on the First Tier up and onto the Cam-Lock Eyelet Seats on the Second Tier. They are threaded for field adjustment so as to not over/under tighten when the Cam-Locks have been fully engaged. Close the Cam-Lock buckles until the Locking Spring Loaded Red Safety Tabs are past the Safety Hasps.

Step 3. When properly attached with all Cam-Locks fully engaged between the First and Second Tier, Eyelets on Cam-Lock Eyelet Seats and Locking Spring Loaded Red Safety Tabs past the Safety Hasps, the Rubber Feet in between each Tier should be slightly compressed with no independent movement between the First and Second Tier. Do not over tighten Cam-Locks or damage will occur. Repeat steps 2 and 3 within the bounds of factory Authorized Stacking Configurations for a Third Tier if desired. Please refer to the factory provided spreadsheets on page 11 for Authorized Stacking Configurations.

Step 4. After all Cam-Locks are fully engaged, using the provided Street 90°/Quick Connect configuration, securely attach the gauges to the Pitots built into each Riptide™. Connection should be tight.

Step 5. In addition to removing twists and kinks, due to the number of connections, extra care must be taken to not cross or tangle the firehose when connecting/threading each Coupling. Utilization of the Typhoon Remote Manifold™, which is inclusive of color-coordinated tubing, can aid in tracking stream performance by providing the ability to operate ball valves and independently assess Waterway activity.

Step 6. While flowing, observe each gauge on each independent Waterway in use and take note of the readings. Reference the factory Pitot chart to convert the observed and noted readings from PSI to GPM for each independent Waterway. After a value in GPM has been determined for each independent Waterway, they should be added together to determine the total volume flowing. The recommended discharge per 2.50" Waterway is 500 GPM. For each additional 500 GPM, another Waterway should be used.

Step 7. Post flow, disengage all Cam-Locks by sliding the Locking Spring Loaded Red Safety Tabs down so that they clear the Safety Hasps, then lift the buckles and unhook the Eyelets in between each Tier from each Eyelet Seat.

Step 8. Refer to steps 9–11 under General Use for further instruction on demobilization.

WATERWAY CONFIGURATIONS

Step 1. Factory Authorized Waterway Configurations vary widely depending on the Riptide™ in use, or the Authorized Stacking Configuration that has been assembled. In all cases, Waterways must be used together to allow for the even distribution of water. Please refer to the factory provided spreadsheets on page 12 for Authorized Waterway Configurations. Only factory Authorized Waterway Configurations are permitted. All relevant instructions under Assembly, Field Ops, Service, Authorized Stacking Configurations, Authorized Waterway Configurations and Authorized Reduced Orifice Insert Configurations apply.

REDUCED ORIFICE INSERT CONFIGURATIONS

Step 1. When appropriate based on site conditions and source characteristics, Riptide™ Reduced Orifice Inserts may be used to capture lower flow rates. Evaluate the condition of the equipment. Look for damage and gasket integrity. Fix or replace any component found to be deficient, prior to use. All relevant instructions under Assembly, Field Ops, Service, Authorized Stacking Configurations, Authorized Waterway Configurations and Authorized Reduced Orifice Insert Configurations applies.

Step 2. Factory Authorized Reduced Orifice Insert Configurations include 1.125” and 1.750” iterations in Single, Double, Triple and Quad Action Riptides™, as well as 3.250” in the LDH 4” Riptide™. Please refer to the factory provided spreadsheets on pages 13-17 for Authorized Reduced Orifice Insert Configurations. All relevant instructions under Assembly, Field Ops, Service, Authorized Stacking Configurations, Authorized Waterway Configurations and Authorized Reduced Orifice Insert Configurations apply.

Riptide ALX Addendum: In addition to the requirements noted above and throughout this User Guide, the 1.125” and 1.750” Reduced Orifice Inserts are compatible with Single, Double, Triple and Quad Action Riptide ALX models. The 3.250” Reduced Orifice Insert is not compatible with the LDH 4” Riptide ALX or the 4” ALX Pitot.

Step 3. Insert the desired Reduced Orifice Insert into the desired Waterway so that the machined keyway notch on the discharge side shrouds the Pitot. Do not attempt to use the 1.125” or 1.750” Reduced Orifice Inserts in the LDH 4” Riptide™.

Step 4. Connect/thread the female end of a 2.50” diameter firehose, or 4” for the LDH 4”, to the source being tested.

Step 5. Follow all remaining steps under General Use, 3 through 11.

TYPHOON REMOTE MANIFOLD

Step 1. Evaluate the condition of the equipment. Look for broken ball valves, sheared threads, kinked or cut tubing, damaged Quick Connect Fittings, etc. Fix, replace or calibrate any component found to be deficient, prior to use. All relevant instructions under Assembly, Field Ops, Service, Authorized Stacking Configurations, Authorized Waterway Configurations and Authorized Reduced Orifice Insert Configurations apply.

Step 2. Beginning at a location adjacent to the Diffusers, unravel the Jacketed Tubing Assembly towards the desired destination where readings will be observed. Ensure that there are no twists, kinks or loops.

Step 3. After unraveling, return to the Diffuser(s) and securely attach the female Quick Connects on the ends of each tube to the male Quick Connect Plugs on each Street 90°, affixed to each Waterway that will be used during testing. Up to eight Waterways in a single stack (two Quad Action Riptides™) can be monitored with the Typhoon Remote Manifold™. Do not use one Typhoon™ to monitor different Diffuser stacks.

Riptide ALX Addendum: In addition to the requirements noted above and throughout this User Guide, the Typhoon Remote Manifold may be used with Waterways that have been removed from the Riptide Diffuser and installed directly on a source for flow to atmosphere.

Step 4. Return to the desired destination where readings will be observed and securely attach the female Quick Connects on the ends of each tube to the male Quick Connect Plugs on each ball valve across the top of the Manifold. Then securely attach the liquid filled, calibrated, 1% accuracy Riptide™ gauge to the side of the Manifold with the Quick Connect Plug.

Step 5. Close all ball valves on the Manifold to protect the gauge from initially acute pressures.

Step 6. Follow Steps 1-3, and 5-7 under General Use.

Step 7. After water has been introduced and the source has been opened to a satisfactory point, slowly open the bleeder ball valve located on the side of the Manifold opposite from the gauge to purge trapped air until a steady stream of water presents. Then slowly close this ball valve.

Step 8. Independently capture Pitot readings from each Waterway by opening one ball valve at a time on the Typhoon Remote Manifold™. Observe and document the reading on the gauge while a given ball valve is fully open. Then close said ball valve and open another until all ball valves in service have been independently opened and closed with readings documented. Please note that any dissimilarity in elevation between the Manifold and the Waterway actively being monitored will affect readings due to head loss/gain at 0.433 PSI per foot. It is recommended that the Manifold be held at the same level as the Waterway being monitored to provide accurate readings.

Step 9. After flow rates have been achieved, very slowly begin to close the source being tested. It is vital that the source is closed in a predictable, controlled manner without haste or aggressive turns to avoid potential source damage.

Step 10. Detach and coil the Jacketed Tube Assembly. Dry off and store all components in a safe, secure place for future use.

Step 11. Return the work area to the state it was found in upon arrival. Do not leave tools or equipment behind.

SERVICE

REPLACING THE PITOT

Step 1. Using an 11/16” box wrench, remove the old Pitot from the Waterway on The Riptide™ Diffuser by turning it counter-clockwise. Discard the old Pitot after removal.

Step 2. Apply teflon tape to the exterior threads of the new Pitot prior to installation.

Step 3. Thread the new Pitot into the 3/8” threaded hole on the Waterway by turning clockwise until hand tight.

Step 4. Insert the Pitot Alignment Tool into the end of the Waterway referenced above, on the Coupling side. Use the 2.500” Pitot Alignment Tool for all 2.500” Waterways and the 4” Pitot Alignment Tool for the LDH 4”. Take note of the Target Hole at the bottom of the Pitot Alignment Tool.

Step 5. Using an 11/16” box wrench, turn the new Pitot clockwise until the entry port of the Pitot is centered within the Target Hole as viewable at the bottom of the Pitot Alignment Tool.

Step 6. Remove the Pitot Alignment Tool from the Waterway.

Step 7. Set The Riptide™ on the Leveling Table so the the Waterway is pointing straight up, and the handle on the back of the Diffusing Box is sitting within the center cutout of the Leveling Table. Facing The Riptide™ place a magnetic digital angle finder at the 3 o'clock or 9 o'clock orientation on the Waterway and observe the angle on the display. Continue to adjust the legs on the Leveling Table until the angle finder shows 90°.

Riptide ALX Addendum: In addition to the requirements noted above and throughout this User Guide, remove the Waterway from the Receiver and place it on the Leveling Table independent of the Riptide Diffuser. The Coupling should be at the top as pictured. Follow all other instructions in Step 7 and Step 8 for Pitot tuning.

Step 8. With The Riptide™ in the vertical position as described in Step 7 and the Waterway at 90°, place the 11/16" Riptide™ Spanner Wrench cutout on the Pitot hex, then set a magnetic digital angle finder on top of the Spanner. Make micro-adjustments by tuning the orientation of the Pitot with the Spanner until the angle finder reads 0°, +/- 1°. When complete, the Waterway should be at 90°, the Pitot should be at 0°, +/- 1° and the dimple on the Pitot hex should be pointing towards the Coupling.

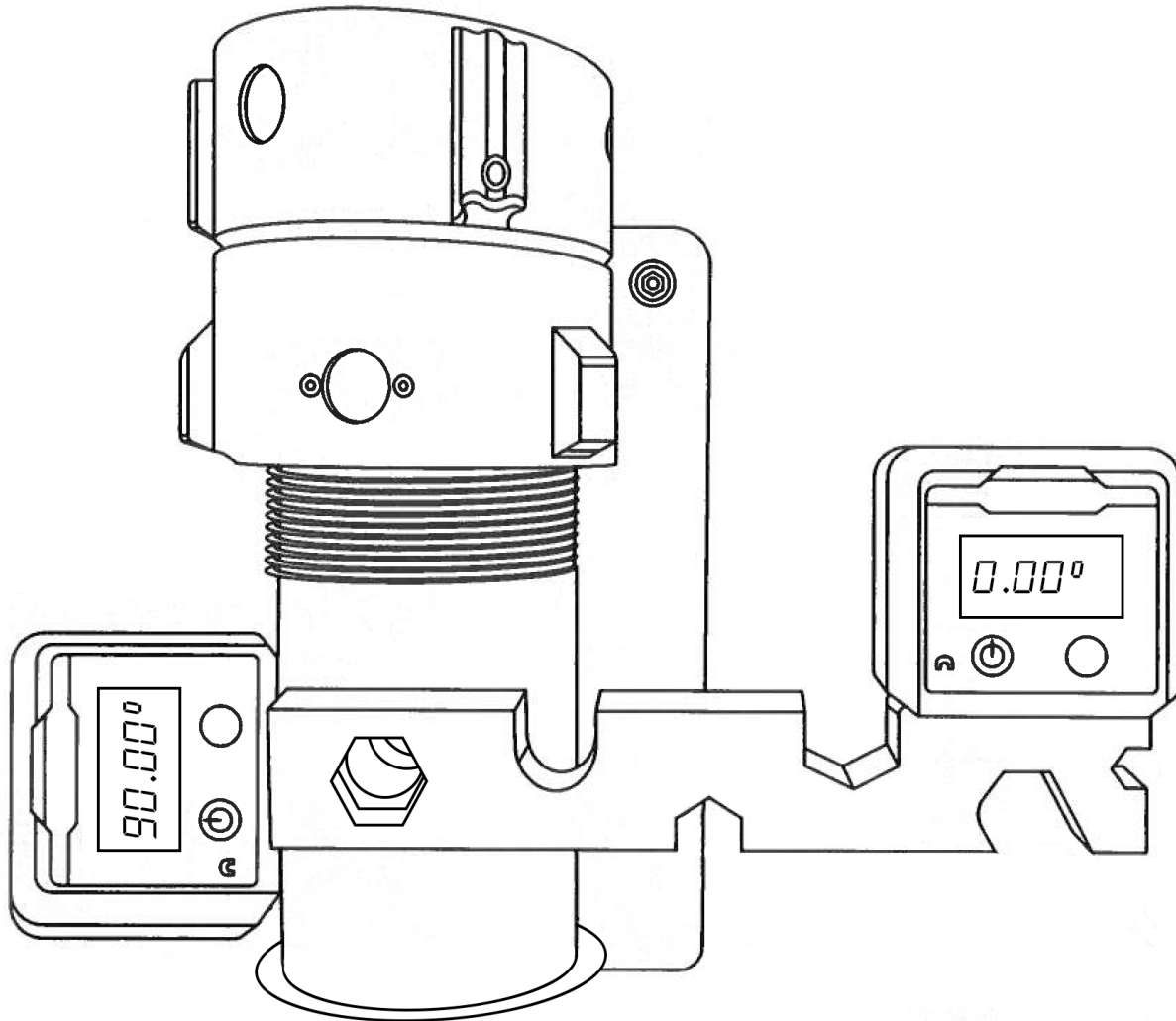

REPLACING THE COUPLING

Step 1. Set The Riptide™ on a smooth, flat, level surface. With the Pitot orientation properly tuned to 0°, +/- 1°, use digital calipers to measure from the back of the Pitot hex, which is the side closest to the Diffusing Box, to the front of the Coupling. This measurement is called a “C-Dimension” and is required to be 6.500”, +/- 0.100”, for all 2.50” Waterways and the LDH 4”.

Step 2. Using a strap wrench with a nylon or fabric strap, remove the old Coupling on The Riptide™ Diffuser by turning it counter-clockwise on the NPT (National Pipe Thread) side. Discard the old Coupling after removal.

Riptide ALX Addendum: In addition to the requirements noted above and throughout this User Guide, do not use the Receiver, Cleats and Cleat Channels as a station for Coupling service. Remove the Waterway from the Receiver and use strap wrenches with nylon or fabric straps as a holdback to loosen the Coupling.

Step 3. Apply teflon tape to the exterior threads on the Waterway prior to installation of the new Coupling.

Step 4. Thread the 2.50”, or 4” for LDH, NPT side of the new Coupling onto the 2.50”, or 4” for LDH, NPT threads on the Waterway referenced above, turning clockwise until hand tight.

Step 5. Using a strap wrench with a nylon or fabric strap, continue to tighten the new Coupling by turning it clockwise. In between turns, capture new C-Dimensions and compare them to the required C-Dimension noted in Step 1 to confirm the proper set of the new Coupling. The new C-Dimension must be 6.500”, +/- 0.100” for all 2.50” Waterways and and the LDH 4”. The connection should be water tight.

Riptide ALX Addendum: In addition to the requirements noted above and throughout this User Guide, do not use the Receiver, Cleats and Cleat Channels as a station for Coupling service. Remove the Waterway from the Receiver and use strap wrenches with nylon or fabric straps as a holdback to tighten the Coupling.

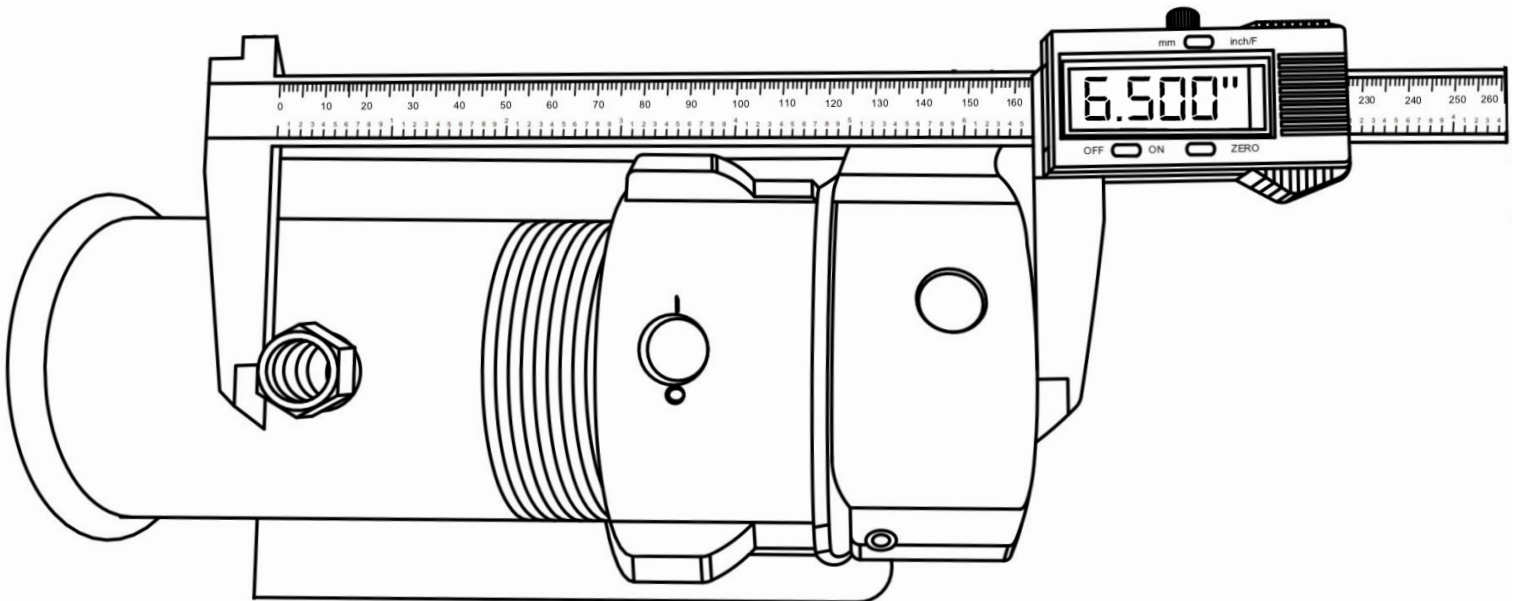

REPLACING THE RECEIVER (ALX MODELS ONLY)

Step 1. Remove the Waterway from the Receiver being serviced. Refer to Step 2 under General Use for further instruction on Waterway removal.

Step 2. Using an 11mm socket and a 5/32" allen wrench, loosen each of the four Nylon Locking Nuts and Bolts in the square bracket around the Receiver being serviced by turning counterclockwise. Fully remove the Nylon Locking Nuts, Washers and Bolts. Retain them for future use.

Step 3. Slide the Receiver being serviced away from the Diffusing Box until fully removed, then discard it. If desired, harvest the Pin Lock, Pin Lock Spacer and Cleats as spare parts for future repairs if they are free of damage and in good working order.

Step 4. Slide the new Receiver into the Diffusing Box so that the Receiver Cove is facing up. Insert the new Bolts through each of the four holes on the square bracket around the Receiver from outside of the Diffusing Box so that the threaded portion of the Bolts protrudes within the Diffusing Box. Within the Diffusing Box, apply a Washer and Nylon Locking Nut on each of the bolts, then turn them clockwise until hand tight.

Step 5. Using an 11mm socket and a 5/32" allen wrench, tighten each of the four Nylon Locking Nuts and Bolts around the Receiver being serviced by turning clockwise. Tighten to 40 lb. in. of torque.

Step 6. Place the Pin Lock Spacer on the Pin Lock so that the contoured side of the Spacer is closest to the retractable Pin. Apply Permatex Threadlocker Blue™ to the end of the Pin Lock threads so that all peaks and valleys of the exposed threads are fully coated.

Step 7. Thread the Pin Lock into the threaded port located at the 3 o'clock or 9 o'clock position on the Receiver being serviced by turning it clockwise until hand tight. All Receivers have both ports. Either is acceptable, except on Triple Action ALX models on the bottom-most Waterways and Quad Action ALX models on all Waterways where due to the overall configuration, spacial constraints will force port selection. While tightening, observe and adjust the Pin Lock Spacer so that the contoured edge tightly hugs the circumference of the Receiver.

Step 8. Using a 19mm box wrench, tighten the Pin Lock by turning clockwise. Tighten to 20 lb. in. of torque.

Step 9. Slide the Waterway that was removed in Step 1 into the new Receiver. Refer to Step 10 under General Use for further instruction on Waterway installation.

REPLACING THE PIN LOCK (ALX MODELS ONLY)

Step 1. Remove the Waterway from the Receiver with the Pin Lock being serviced. Refer to Step 2 under General Use for further instruction on Waterway removal.

Step 2. Using a 19mm box wrench, turn the Pin Lock counterclockwise to initially loosen it. Then continue to unthread it by hand by further turning counterclockwise until it can be removed.

Step 3. Harvest the Pin Lock Spacer if it is free of damage and in good working order. If not, a new one is needed for proper installation of the new Pin Lock.

Step 4. Refer to Steps 6-9 under Replacing The Receiver for further instruction on Replacing the Pin Lock.

REPLACING THE CLEATS (ALX MODELS ONLY)

Step 1. Remove the Waterway from the Receiver with Cleats being serviced. Refer to Step 2 under General Use for further instruction on Waterway removal.

Step 2. Using a 11mm socket and a 5/32" allen wrench, loosen each of the four Nylon Locking Nuts and Bolts in the square bracket around the Receiver with Cleats being serviced by turning them counterclockwise. Fully remove the Nylon Locking Nuts, Washers and Bolts. Retain them for future use.

Step 3. Slide the Receiver being serviced away from the Diffusing Box until fully removed, then using a 3/16" allen wrench, turn all Cleats which require service counterclockwise until they can be removed. Once removed, discard them.

Step 4. Apply Permatex Threadlocker Blue™ to the end of the new Cleat threads so that all peaks and valleys are fully coated. Using a 3/16" allen wrench, thread each new Cleat into place by turning them clockwise until they protrude 1/16" within the Receiver.

Step 5. Slide the Waterway that was removed in Step 1 into the Receiver. Refer to Step 10 under General Use for further instruction on Waterway installation.

Step 6. With the Waterway in the Receiver, continue to tighten all Cleats by turning them clockwise until they are snug against the bottom of the Waterway Cleat Channels. All Cleats should be evenly set so that they all protrude inside of the Receiver equally. Do not overtighten Cleats or Waterway damage will occur. They should merely touch the bottom of the Waterway Cleat Channels.

Step 7. Back off each Cleat by turning 1/16 to 1/8 of a turn counterclockwise so that the Waterway can slide in and out of the Receiver freely. Verify that all Cleats protrude within the Receiver by removing the Waterway and observing their positioning. Verify that the Cleats hold the Waterway in position by fully installing it in the Receiver, retracting the Pin on the Pin Lock and pulling the Waterway away from the Receiver without turning it counterclockwise first.

Step 8. Allow 24 hours of cure time for the Permatex Threadlocker Blue™ in a warm (72°F or greater), dry place.

Step 9. Slide the Receiver into the Diffusing Box so that the Receiver Cove is facing up. Insert the Bolts through each of the four holes on the square bracket around the Receiver from outside of the Diffusing Box so that the threaded portion of the Bolts protrudes within the Diffusing Box. Within the Diffusing Box, apply a Washer and Nylon Locking Nut on each of the bolts, then turn them clockwise until hand tight.

Step 10. Using a 11mm socket and a 5/32" allen wrench, tighten each of the four Nylon Locking Nuts and Bolts around the Receiver with Cleats being serviced by turning clockwise. Tighten to 40 lb. in. of torque.

Step 11. Slide the Waterway that was removed in Step 1 into the new Receiver. Refer to Step 10 under General Use for further instruction on Waterway installation.

OTHER COMPONENTS

Please refer to the Assembly portion of this guide on page 2 for instructions on how to service other elements of The Riptide Flow Testing System™ and The Riptide Flow Testing System ALX™.

DISCLAIMER

FIRE PUMP FLOW TESTING EQUIPMENT UNIT EX29051 THE RIPTIDE FLOW TESTING SYSTEM



AS TO FLOW MEASUREMENT ACCURACY SPECIFIED BY THE MANUFACTURER WHEN INSTALLED IN ACCORDANCE WITH THE MANUFACTURERS INSTALLATION INSTRUCTIONS

Use of this product is subject to all terms and conditions found at www.hydra-tap.com. Flowing water is inherently dangerous. The purchaser and all users of The Riptide Flow Testing System™ and The Riptide Flow Testing System ALX™ accept all liability for any damage to property or injury to person, including death, that may occur. Modifications, misuse, abuse, use with damaged components, use with an improper firehose diameter or improperly maintained firehose, and repairs without factory provided parts will void all warranties. All information in this user guide is subject to change without notice at any time. It is the responsibility of the purchaser and all users to stay up to date on revisions. By purchasing and/or using this product you agree to all terms and fully release Hydra-Tap LLC, suppliers of raw materials, fabricators, and distributors of all liabilities.

FIRE PUMP FLOW TESTING EQUIPMENT UNIT EX29051 THE RIPTIDE FLOW TESTING SYSTEM ALX



AS TO FLOW MEASUREMENT ACCURACY SPECIFIED BY THE MANUFACTURER WHEN INSTALLED IN ACCORDANCE WITH THE MANUFACTURERS INSTALLATION INSTRUCTIONS

AUTHORIZED STACKING CONFIGURATIONS

Riptide ALX may never be placed underneath a legacy steel Riptide when stacking.

TIER 3		○					
TIER 2	○	○	○	○ ○	○	○ ○	○ ○ ○
TIER 1	○	○	○ ○	○ ○	○ ○ ○	○ ○ ○	○ ○ ○

TIER 3									
TIER 2	○	○	○ ○	○ ○ ○	○ ○ ○ ○	○	○	○ ○	○ ○ ○
TIER 1	○ ○ ○ ○	○ ○ ○ ○	○ ○ ○ ○	○ ○ ○ ○	○ ○ ○ ○	○	○	○	○



AUTHORIZED WATERWAY CONFIGURATIONS

In this section, solid black circles indicate active Waterways (flowing). Open black circles indicate inactive Waterways (not flowing).

TIER 3									
TIER 2									
TIER 1									



TIER 3								
TIER 2								
TIER 1								

TIER 3									
TIER 2									
TIER 1									

TIER 3									
TIER 2									
TIER 1									

AUTHORIZED REDUCED ORIFICE INSERT CONFIGURATIONS

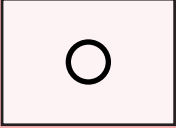
SINGLE ACTION ORIFICE CHART

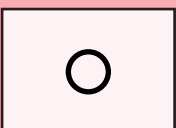
TIER 3 	SINGLE ACTION	2.50"	1.75"	1.75"	1.75"	1.125"	1.125"	1.125"	1.125"	1.125"	1.125"
		2.50"	2.50"	1.75"	1.75"	2.50"	1.75"	1.75"	1.125"	1.125"	1.125"
TIER 2 	SINGLE ACTION	2.50"	2.50"	1.75"	1.75"	2.50"	1.75"	1.75"	1.125"	1.125"	1.125"
TIER 1 	SINGLE ACTION	2.50"	2.50"	2.50"	1.75"	2.50"	2.50"	1.75"	2.5"	1.75"	1.125"

DOUBLE ACTION ORIFICE CHART

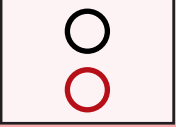
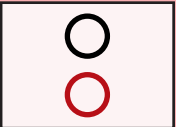
TIER 2 	DOUBLE ACTION	2.50"	1.75"	1.75"	1.75"	1.75"	1.125"	1.125"	1.125"	1.125"	1.125"	1.125"	1.125"	1.125"	1.125"
		2.50"	2.50"	1.75"	1.75"	1.75"	2.50"	1.75"	1.75"	1.75"	1.125"	1.125"	1.125"	1.125"	1.125"
TIER 1 	DOUBLE ACTION	2.50"	2.50"	2.50"	1.75"	1.75"	2.50"	2.50"	1.75"	1.75"	2.50"	1.75"	1.75"	1.125"	1.125"
		2.50"	2.50"	2.50"	2.50"	1.75"	2.50"	2.50"	2.50"	1.75"	2.50"	2.50"	1.75"	2.50"	1.75"

TRIPLE ACTION ORIFICE CHART

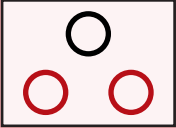
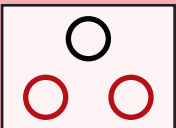
TIER 2 	TRIPLE ACTION	2.50"	1.75"	1.75"	1.75"	1.75"	1.125"	1.125"	1.125"	1.125"	1.125"	1.125"	1.125"	1.125"	1.125"
		2.50"	2.50"	1.75"	1.75"	1.75"	2.50"	1.75"	1.75"	1.75"	1.125"	1.125"	1.125"	1.125"	1.125"
		2.50"	2.50"	1.75"	1.75"	1.75"	2.50"	1.75"	1.75"	1.75"	1.125"	1.125"	1.125"	1.125"	1.125"
TIER 1 	TRIPLE ACTION	2.50"	2.50"	2.50"	1.75"	1.75"	2.50"	2.50"	1.75"	1.75"	2.50"	1.75"	1.75"	1.125"	1.125"
		2.50"	2.50"	2.50"	2.50"	1.75"	2.50"	2.50"	2.50"	1.75"	2.50"	2.50"	1.75"	2.50"	1.75"
		2.50"	2.50"	2.50"	2.50"	1.75"	2.50"	2.50"	2.50"	1.75"	2.50"	2.50"	1.75"	2.50"	1.75"

QUAD ACTION ORIFICE CHART

TIER 2 	LDH 4" ACTION	2.50"	1.75"	1.75"	1.75"	1.75"	1.125"	1.125"	1.125"	1.125"	1.125"	1.125"	1.125"	1.125"	1.125"
		2.50"	1.75"	1.75"	1.75"	1.75"	1.125"	1.125"	1.125"	1.125"	1.125"	1.125"	1.125"	1.125"	1.125"
TIER 1 	QUAD ACTION	2.50"	2.50"	2.50"	1.75"	1.75"	2.50"	2.50"	1.75"	1.75"	2.50"	1.75"	1.75"	1.125"	1.125"
		2.50"	2.50"	2.50"	1.75"	1.75"	2.50"	2.50"	1.75"	1.75"	2.50"	1.75"	1.75"	1.125"	1.125"

LDH 4" ORIFICE CHART

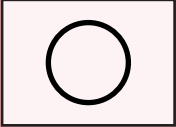
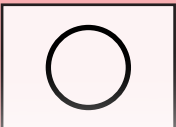
TIER 2 	LDH 4" ACTION	4"	3.25"	3.25"
TIER 1 		LDH 4" ACTION	4"	4"

LDH 4" ACTION/SINGLE ACTION ORIFICE CHART

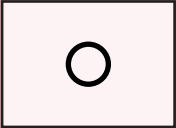
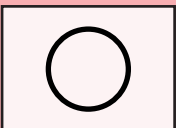
TIER 2 	DOUBLE ACTION	2.50"	1.75"	1.125"	2.50"	1.75"	1.125"
TIER 1 		QUAD ACTION	4"	4"	4"	3.25"	3.25"

SINGLE/DOUBLE ORIFICE CHART

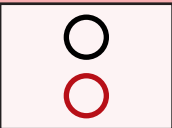
TIER 2 	SINGLE ACTION	2.50"	1.75"	1.75"	1.75"	1.125"	1.125"	1.125"	1.125"	1.125"	1.125"
TIER 1 	DOUBLE ACTION	2.50"	2.50"	1.75"	1.75"	2.50"	1.75"	1.75"	1.125"	1.125"	1.125"
		2.50"	2.50"	2.50"	1.75"	2.50"	2.50"	1.75"	2.50"	1.75"	1.125"

SINGLE/TRIPLE ORIFICE CHART

TIER 2 	SINGLE ACTION	2.50"	1.75"	1.75"	1.75"	1.125"	1.125"	1.125"	1.125"	1.125"	1.125"
TIER 1 	TRIPLE ACTION	2.50"	2.50"	1.75"	1.75"	2.50"	1.75"	1.75"	1.125"	1.125"	1.125"
		2.50"	2.50"	2.50"	1.75"	2.50"	2.50"	1.75"	2.50"	1.75"	1.125"
		2.50"	2.50"	2.50"	1.75"	2.50"	2.50"	1.75"	2.50"	1.75"	1.125"

SINGLE/QUAD ORIFICE CHART

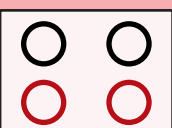
TIER 2 	SINGLE ACTION	2.50"	1.75"	1.75"	1.75"	1.125"	1.125"	1.125"	1.125"	1.125"	1.125"
TIER 1 	QUAD ACTION	2.50"	2.50"	1.75"	1.75"	2.50"	1.75"	1.75"	1.125"	1.125"	1.125"
		2.50"	2.50"	1.75"	1.75"	2.50"	1.75"	1.75"	1.125"	1.125"	1.125"
		2.50"	2.50"	2.50"	1.75"	2.50"	2.50"	1.75"	2.50"	1.75"	1.125"
		2.50"	2.50"	2.50"	1.75"	2.50"	2.50"	1.75"	2.50"	1.75"	1.125"

DOUBLE/LDH 4" ORIFICE CHART

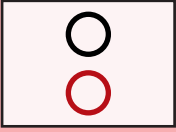
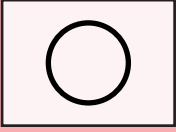
TIER 2 	DOUBLE ACTION	2.50"	1.75"	1.75"	1.125"	1.125"	1.125"	2.50"	1.75"	1.75"	1.125"	1.125"	1.125"
		2.50"	2.50"	1.75"	2.50"	1.75"	1.125"	2.50"	2.50"	1.75"	2.50"	1.75"	1.125"
TIER 1 	LDH 4" ACTION	4"	4"	4"	4"	4"	4"	3.25"	3.25"	3.25"	3.25"	3.25"	3.25"
		4"	4"	4"	4"	4"	4"	3.25"	3.25"	3.25"	3.25"	3.25"	3.25"

DOUBLE/TRIPLE ORIFICE CHART

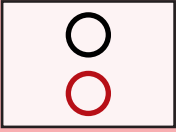
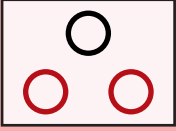
TIER 2 	DOUBLE ACTION	2.50"	1.75"	1.75"	1.75"	1.75"	1.125"	1.125"	1.125"	1.125"	1.125"	1.125"	1.125"	1.125"	1.125"	
		2.50"	2.50"	1.75"	1.75"	1.75"	2.50"	1.75"	1.75"	1.75"	1.125"	1.125"	1.125"	1.125"	1.125"	
TIER 1 	TRIPLE ACTION	2.50"	2.50"	2.50"	1.75"	1.75"	2.50"	2.50"	1.75"	1.75"	2.50"	1.75"	1.75"	1.125"	1.125"	1.125"
		2.50"	2.50"	2.50"	2.50"	1.75"	2.50"	2.50"	2.50"	1.75"	2.50"	2.50"	1.75"	2.50"	1.75"	1.125"
		2.50"	2.50"	2.50"	2.50"	1.75"	2.50"	2.50"	2.50"	1.75"	2.50"	2.50"	1.75"	2.50"	1.75"	1.125"

DOUBLE/QUAD ORIFICE CHART

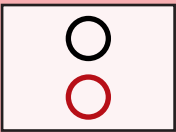
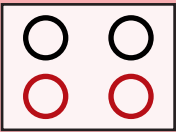
TIER 2 	DOUBLE ACTION	2.50"	1.75"	1.75"	1.75"	1.75"	1.125"	1.125"	1.125"	1.125"	1.125"	1.125"	1.125"	
		2.50"	2.50"	1.75"	1.75"	1.75"	1.75"	1.75"	1.75"	1.125"	1.125"	1.125"	1.125"	
TIER 1 	QUAD ACTION	2.50"	2.50"	2.50"	1.75"	1.75"	2.50"	1.75"	1.75"	2.50"	1.75"	1.75"	1.125"	1.125"
		2.50"	2.50"	2.50"	1.75"	1.75"	2.50"	1.75"	1.75"	2.50"	1.75"	1.75"	1.125"	1.125"
		2.50"	2.50"	2.50"	2.50"	1.75"	2.50"	2.50"	1.75"	2.50"	2.50"	1.75"	1.75"	1.125"
		2.50"	2.50"	2.50"	2.50"	1.75"	2.50"	2.50"	1.75"	2.50"	2.50"	1.75"	1.75"	1.125"

TRIPLE/LDH 4" ORIFICE CHART

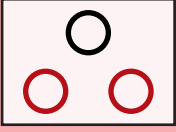
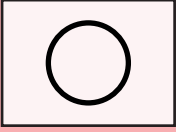
TIER 2 	TRIPLE ACTION	2.50"	1.75"	1.75"	1.125"	1.125"	1.125"	2.50"	1.75"	1.75"	1.125"	1.125"	1.125"
		2.50"	2.50"	1.75"	2.50"	1.75"	1.125"	2.50"	2.50"	1.75"	2.50"	1.75"	1.125"
		2.50"	2.50"	1.75"	2.50"	1.75"	1.125"	2.50"	2.50"	1.75"	2.50"	1.75"	1.125"
TIER 1 	LDH 4" ACTION	4"	4"	4"	4"	4"	4"	3.25"	3.25"	3.25"	3.25"	3.25"	3.25"

QUAD ACTION/TRIPLE ACTION ORIFICE CHART

TIER 2 	DOUBLE ACTION	2.50"	1.75"	1.75"	1.75"	1.75"	1.125"	1.125"	1.125"	1.125"	1.125"	1.125"	1.125"	1.125"
		2.50"	2.50"	1.75"	1.75"	1.75"	2.50"	1.75"	1.75"	1.75"	1.125"	1.125"	1.125"	1.125"
		2.50"	2.50"	1.75"	1.75"	1.75"	2.50"	1.75"	1.75"	1.75"	1.125"	1.125"	1.125"	1.125"
TIER 1 	QUAD ACTION	2.50"	2.50"	2.50"	1.75"	1.75"	2.50"	2.50"	1.75"	1.75"	2.50"	1.75"	1.75"	1.125"
		2.50"	2.50"	2.50"	1.75"	1.75"	2.50"	2.50"	1.75"	1.75"	2.50"	1.75"	1.75"	1.125"
		2.50"	2.50"	2.50"	2.50"	1.75"	2.50"	2.50"	2.50"	1.75"	2.50"	2.50"	1.75"	1.75"
		2.50"	2.50"	2.50"	2.50"	1.75"	2.50"	2.50"	2.50"	1.75"	2.50"	2.50"	1.75"	1.125"

LDH 4"/QUAD ORIFICE CHART

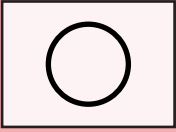
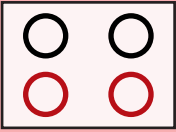
TIER 2 	LDH 4" ACTION	4"	4"	4"	4"	4"	4"	3.25"	3.25"	3.25"	3.25"	3.25"	3.25"
TIER 1 	QUAD ACTION	2.50"	1.75"	1.75"	1.125"	1.125"	1.125"	2.50"	1.75"	1.75"	1.125"	1.125"	1.125"
		2.50"	1.75"	1.75"	1.125"	1.125"	1.125"	2.50"	1.75"	1.75"	1.125"	1.125"	1.125"
		2.50"	2.50"	1.75"	2.50"	1.75"	1.125"	2.50"	2.50"	1.75"	2.50"	1.75"	1.125"
		2.50"	2.50"	1.75"	2.50"	1.75"	1.125"	2.50"	2.50"	1.75"	2.50"	1.75"	1.125"



THE RIPTIDE FLOW TESTING SYSTEM™



PSI	1.125"	1.75"	2.5"	PSI	1.125"	1.75"	2.5"	PSI	1.125"	1.75"	2.5"
1	-	-	-	51	178.8	456.2	882.0	101	251.6	642.0	1241.1
2	-	-	-	52	180.5	460.7	890.6	102	252.8	645.2	1247.3
3	-	-	-	53	182.2	465.1	899.1	103	254.1	648.3	1253.4
4	-	-	-	54	184.0	469.4	907.5	104	255.3	651.5	1259.4
5	-	-	-	55	185.7	473.8	915.9	105	256.5	654.6	1265.5
6	-	-	-	56	187.3	478.1	924.2	106	257.7	657.7	1271.5
7	-	-	-	57	189.0	482.3	932.4	107	259.0	660.8	1277.5
8	-	-	-	58	190.7	486.5	940.5	108	260.2	663.9	1283.4
9	-	-	-	59	192.3	490.7	948.6	109	261.4	667.0	1289.4
10	79.2	-	-	60	193.9	494.8	956.6	110	262.6	670.0	1295.3
11	83.0	-	-	61	195.5	498.9	964.6	111	263.7	673.0	1301.1
12	86.7	-	-	62	197.1	503.0	972.4	112	264.9	676.1	1307.0
13	90.3	-	-	63	198.7	507.1	980.2	113	266.1	679.1	1312.8
14	93.7	-	-	64	200.3	511.1	988.0	114	267.3	682.1	1318.6
15	97.0	-	-	65	201.8	515.0	995.7	115	268.5	685.1	1324.4
16	100.1	255.5	494.0	66	203.4	519.0	1003.3	116	269.6	688.0	-
17	103.2	263.4	509.2	67	204.9	522.9	1010.9	117	270.8	691.0	-
18	106.2	271.0	524.0	68	206.4	526.8	1018.4	118	271.9	693.9	-
19	109.1	278.5	538.3	69	207.9	530.6	1025.9	119	273.1	696.9	-
20	112.0	285.7	552.3	70	209.4	534.5	1033.3	120	274.2	699.8	-
21	114.7	292.7	565.9	71	210.9	538.3	1040.6	121	275.4	702.7	-
22	117.4	299.6	579.3	72	212.4	542.1	1047.9	122	276.5	705.6	-
23	120.1	306.4	592.3	73	213.9	545.8	1055.2	123	277.6	708.5	-
24	122.6	313.0	605.0	74	215.4	549.5	1062.4	124	278.8	711.4	-
25	125.2	319.4	617.5	75	216.8	553.2	1069.5	125	279.9	714.2	-
26	127.6	325.7	629.7	76	218.2	556.9	1076.6	126	281.0	717.1	-
27	130.1	331.9	641.7	77	219.7	560.6	1083.7	127	282.1	719.9	-
28	132.5	338.0	653.5	78	221.1	564.2	1090.7	128	283.2	722.7	-
29	134.8	344.0	665.1	79	222.5	567.8	1097.7	129	284.3	725.6	-
30	137.1	349.9	676.4	80	223.9	571.4	1104.6	130	285.4	728.4	-
31	139.4	355.7	687.6	81	225.3	574.9	1111.5	131	286.5	731.2	-
32	141.6	361.4	698.6	82	226.7	578.5	1118.3	132	287.6	734.0	-
33	143.8	367.0	709.4	83	228.1	582.0	1125.1	133	288.7	736.7	-
34	146.0	372.5	720.1	84	229.4	585.5	1131.9	134	289.8	739.5	-
35	148.1	377.9	730.6	85	230.8	589.0	1138.6	135	290.9	742.2	-
36	150.2	383.3	741.0	86	232.2	592.4	1145.3	136	291.9	745.0	-
37	152.3	388.6	751.2	87	233.5	595.9	1151.9	137	293.0	-	-
38	154.3	393.8	761.3	88	234.8	599.3	1158.5	138	294.1	-	-
39	156.3	398.9	771.2	89	236.2	602.7	1165.1	139	295.1	-	-
40	158.3	404.0	781.1	90	237.5	606.0	1171.6	140	296.2	-	-
41	160.3	409.0	790.8	91	238.8	609.4	1178.1	141	297.3	-	-
42	162.2	414.0	800.4	92	240.1	612.7	1184.6	142	298.3	-	-
43	164.2	418.9	809.8	93	241.4	616.1	1191.0	143	299.4	-	-
44	166.1	423.7	819.2	94	242.7	619.4	1197.4	144	300.4	-	-
45	167.9	428.5	828.5	95	244.0	622.6	1203.7	145	301.4	-	-
46	169.8	433.3	837.6	96	245.3	625.9	1210.0	146	-	-	-
47	171.6	438.0	846.7	97	246.6	629.2	1216.3	147	-	-	-
48	173.4	442.6	855.6	98	247.8	632.4	1222.6	148	-	-	-
49	175.2	447.2	864.5	99	249.1	635.6	1228.8	149	-	-	-
50	177.0	451.7	873.3	100	250.3	638.8	1235.0	150	-	-	-

All laboratory instrumentation used in the creation of this chart is ISO 17025 traceable.

Readings were found to be accurate to within +/-2%.

D (in)	AVERAGE C	FLOW RANGE
1.125"	0.6629	79.2 - 301.4
1.750"	0.6990	255.5 - 745.0
2.493"	0.6659	494.0 - 1324.4

$$Q = 29.84 \times C \times D^2 \times \sqrt{P}$$

1.125"

Refer to the data in this column when operating The Riptide™ with a 1.125" Reduced Orifice Insert.

1.75"

Refer to the data in this column when operating The Riptide™ with a 1.75" Reduced Orifice Insert.

2.50"

Refer to the data in this column when operating The Riptide™ without a Reduced Orifice Insert.

MULTI-STREAM OPERATION

Readings should be taken at each stream with each independent correlating GPM added together to determine the total volume flowing.

2.50" RIPTIDE PITOT



2.055"





THE RIPTIDE FLOW TESTING SYSTEM™



PSI	3.25"	4"	PSI	3.25"	4"
1	-	-	51	1812.3	2481.7
2	-	-	52	1830.0	2505.9
3	-	-	53	1847.5	2529.9
4	-	-	54	1864.8	2553.7
5	-	-	55	1882.0	2577.2
6	-	-	56	1899.0	2600.5
7	-	-	57	1915.9	2623.6
8	-	-	58	1932.7	2646.6
9	-	-	59	1949.2	2669.3
10	-	-	60	1965.7	2691.8
11	841.7	1152.6	61	1982.0	2714.1
12	879.1	1203.8	62	1998.2	2736.3
13	915.0	1253.0	63	2014.2	2758.3
14	949.5	1300.3	64	2030.2	2780.1
15	982.8	1345.9	65	2046.0	2801.7
16	1015.1	1390.0	66	2061.6	2823.2
17	1046.3	1432.8	67	2077.2	2844.5
18	1076.7	1474.4	68	2092.6	2865.6
19	1106.2	1514.8	69	2108.0	2886.6
20	1134.9	1554.1	70	-	2907.5
21	1162.9	1592.5	71	-	2928.2
22	1190.3	1630.0	72	-	-
23	1217.0	1666.6	73	-	-
24	1243.2	1702.4	74	-	-
25	1268.8	1737.6	75	-	-
26	1294.0	1772.0	76	-	-
27	1318.6	1805.7	77	-	-
28	1342.8	1838.9	78	-	-
29	1366.6	1871.4	79	-	-
30	1390.0	1903.4	80	-	-
31	1412.9	1934.9	81	-	-
32	1435.5	1965.8	82	-	-
33	1457.8	1996.3	83	-	-
34	1479.7	2026.3	84	-	-
35	1501.3	2055.9	85	-	-
36	1522.6	2085.1	86	-	-
37	1543.6	2113.8	87	-	-
38	1564.3	2142.2	88	-	-
39	1584.8	2170.2	89	-	-
40	1605.0	2197.9	90	-	-
41	1624.9	2225.2	91	-	-
42	1644.6	2252.1	92	-	-
43	1664.1	2278.8	93	-	-
44	1683.3	2305.1	94	-	-
45	1702.3	2331.2	95	-	-
46	1721.1	2356.9	96	-	-
47	1739.8	2382.4	97	-	-
48	1758.2	2407.6	98	-	-
49	1776.4	2432.6	99	-	-
50	1794.4	2457.3	100	-	-

All laboratory instrumentation used in the creation of this chart is ISO 17025 traceable.

Readings were found to be accurate to within +/-2%.

D (in)	AVERAGE C	FLOW RANGE
3.250"	0.8051	841.7 - 2108.0
4.000"	0.7279	1152.6 - 2928.2

$$Q = 29.84 \times C \times D^2 \times \sqrt{P}$$

3.25"

Refer to the data in this column when operating The Riptide™ with a 3.25" Reduced Orifice Insert.

4"

Refer to the data in this column when operating The Riptide™ without a Reduced Orifice Insert.

MULTI-STREAM OPERATION

Readings should be taken at each stream with each independent correlating GPM added together to determine the total volume flowing.

4" RIPTIDE PITOT

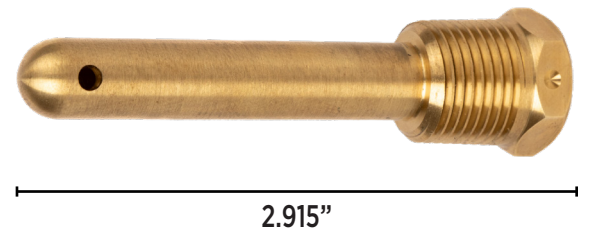

FIRE PUMP FLOW TESTING EQUIPMENT UNIT EX29051 THE RIPTIDE FLOW TESTING SYSTEM

AS TO FLOW MEASUREMENT ACCURACY SPECIFIED BY THE MANUFACTURER WHEN INSTALLED IN ACCORDANCE WITH THE MANUFACTURERS INSTALLATION INSTRUCTIONS





THE RIPTIDE FLOW TESTING SYSTEM™



PSI	1.125"	1.75"	2.5"	PSI	1.125"	1.75"	2.5"	PSI	1.125"	1.75"	2.5"
1	-	-	-	51	221.6	538.4	-	101	311.9	-	-
2	43.9	-	-	52	223.8	543.6	-	102	313.4	-	-
3	53.8	130.6	-	53	225.9	548.8	-	103	315.0	-	-
4	62.1	150.8	-	54	228.1	554.0	-	104	316.5	-	-
5	69.4	168.6	-	55	230.2	559.1	-	105	318.0	-	-
6	76.0	184.7	-	56	232.2	564.1	-	106	319.5	-	-
7	82.1	199.5	-	57	234.3	569.1	-	107	321.0	-	-
8	87.8	213.2	-	58	236.4	574.1	-	108	322.5	-	-
9	93.1	226.2	-	59	238.4	579.0	-	109	324.0	-	-
10	98.1	238.4	-	60	240.4	583.9	-	110	325.5	-	-
11	102.9	250.0	-	61	242.4	588.8	-	111	327.0	-	-
11.3	104.2	253.7	500.0	62	244.4	593.6	-	112	328.4	-	-
12	107.5	261.1	515.2	63	246.3	598.4	-	113	329.9	-	-
13	111.9	271.8	536.3	64	248.3	603.1	-	114	331.4	-	-
14	116.1	282.1	556.5	65	250.2	607.8	-	115	332.8	-	-
15	120.2	292.0	576.0	66	252.1	612.4	-	116	334.3	-	-
16	124.1	301.5	594.9	67	254.0	617.1	-	117	335.7	-	-
17	128.0	310.8	613.2	68	255.9	621.6	-	118	337.1	-	-
18	131.7	319.8	631.0	69	257.8	626.2	-	119	338.6	-	-
19	135.3	328.6	648.3	70	259.7	630.7	-	120	340.0	-	-
20	138.8	337.1	665.2	71	261.5	635.2	-	121	341.4	-	-
21	142.2	345.5	681.6	72	263.3	639.7	-	122	342.8	-	-
22	145.6	353.6	697.6	73	265.2	644.1	-	123	344.2	-	-
23	148.8	361.5	713.3	74	267.0	648.5	-	124	345.6	-	-
24	152.0	369.3	728.6	75	268.8	652.9	-	125	347.0	-	-
25	155.2	376.9	743.7	76	270.6	657.2	-	126	348.4	-	-
26	158.3	384.4	758.4	77	272.3	661.5	-	127	349.8	-	-
27	161.3	391.7	772.8	78	274.1	665.8	-	128	351.1	-	-
28	164.2	398.9	787.0	79	275.8	670.0	-	129	352.5	-	-
29	167.1	406.0	801.0	80	277.6	674.3	-	130	353.9	-	-
30	170.0	412.9	814.6	81	279.3	678.5	-	131	355.2	-	-
31	172.8	419.7	828.1	82	281.0	682.6	-	132	356.6	-	-
32	175.6	426.4	841.4	83	282.7	686.8	-	133	357.9	-	-
33	178.3	433.1	854.4	84	284.4	690.9	-	134	359.3	-	-
34	181.0	439.6	867.3	85	286.1	695.0	-	135	360.6	-	-
35	183.6	446.0	879.9	86	287.8	699.1	-	136	361.9	-	-
36	186.2	452.3	892.4	87	289.5	703.1	-	137	363.3	-	-
37	188.8	458.6	904.7	88	291.1	707.2	-	138	-	-	-
38	191.3	464.7	916.9	89	292.8	711.2	-	139	-	-	-
39	193.8	470.8	928.8	90	294.4	715.2	-	140	-	-	-
40	196.3	476.8	940.7	91	296.1	719.1	-	141	-	-	-
41	198.7	492.7	952.4	92	297.7	723.1	-	142	-	-	-
42	201.1	488.6	963.9	93	299.3	727.0	-	143	-	-	-
43	203.5	494.3	975.3	94	300.9	730.9	-	144	-	-	-
44	205.9	500.1	986.6	95	302.5	734.8	-	145	-	-	-
45	208.2	505.7	997.7	96	304.1	738.6	-	146	-	-	-
46	210.5	511.3	1008.8	97	305.7	742.5	-	147	-	-	-
47	212.8	516.8	1019.7	98	307.2	746.3	-	148	-	-	-
48	215.0	522.3	-	99	308.8	750.1	-	149	-	-	-
49	217.2	527.7	-	100	310.4	-	-	150	-	-	-
50	219.5	533.1	-								

All laboratory instrumentation used in the creation of this chart is ISO 17025 traceable.

Readings were found to be accurate to within +/-1.75%.

D (in)	AVERAGE C	FLOW RANGE
1.125"	0.8218	43.9 - 363.3
1.750"	0.8249	130.6 - 750.1
2.493"	0.8020	500.0 - 1019.7

$$Q = 29.84 \times C \times D^2 \times \sqrt{P}$$

1.125"

Refer to the data in this column when operating The Riptide™ with a 1.125" Reduced Orifice Insert.

1.75"

Refer to the data in this column when operating The Riptide™ with a 1.75" Reduced Orifice Insert.

2.50"

Refer to the data in this column when operating The Riptide™ without a Reduced Orifice Insert.

MULTI-STREAM OPERATION

Readings should be taken at each stream with each independent correlating GPM added together to determine the total volume flowing.

2.50" RIPTIDE ALX PITOT



1.88"



FIRE PUMP FLOW TESTING EQUIPMENT UNIT EX29051 THE RIPTIDE FLOW TESTING SYSTEM ALX

AS TO FLOW MEASUREMENT ACCURACY SPECIFIED BY THE MANUFACTURER WHEN INSTALLED IN ACCORDANCE WITH THE MANUFACTURERS INSTALLATION INSTRUCTIONS





THE RIPTIDE FLOW TESTING SYSTEM™



PSI	4"	PSI	4"
1	-	51	-
2	-	52	-
3	-	53	-
4	-	54	-
5	910.8	55	-
6	997.7	56	-
7	1077.6	57	-
8	1152.0	58	-
9	1221.9	59	-
10	1288.0	60	-
11	1350.9	61	-
12	1410.9	62	-
13	1468.5	63	-
14	1524.0	64	-
15	1577.5	65	-
16	1629.2	66	-
17	1679.3	67	-
18	1728.0	68	-
19	1775.4	69	-
20	1821.5	70	-
21	1866.5	71	-
22	1910.4	72	-
23	1953.3	73	-
24	1995.3	74	-
25	2036.5	75	-
26	2076.8	76	-
27	2116.4	77	-
28	2155.2	78	-
29	2193.4	79	-
30	2230.9	80	-
31	2267.7	81	-
32	2304.0	82	-
33	2339.7	83	-
34	2374.9	84	-
35	2409.6	85	-
36	2443.8	86	-
37	2477.5	87	-
38	2510.7	88	-
39	2543.6	89	-
40	2576.0	90	-
41	2608.0	91	-
42	2639.6	92	-
43	2670.8	93	-
44	2701.7	94	-
45	-	95	-
46	-	96	-
47	-	97	-
48	-	98	-
49	-	99	-
50	-	100	-

All laboratory instrumentation used in the creation of this chart is ISO 17025 traceable.

Readings were found to be accurate to within +/-1.75%.

D (in)	AVERAGE C	FLOW RANGE
4.000"	0.8531	910.8 - 2701.7

$$Q = 29.84 \times C \times D^2 \times \sqrt{P}$$

4"

Refer to the data in this column when operating The Riptide™ without a Reduced Orifice Insert.

MULTI-STREAM OPERATION

Readings should be taken at each stream with each independent correlating GPM added together to determine the total volume flowing.

4" RIPTIDE ALX PITOT

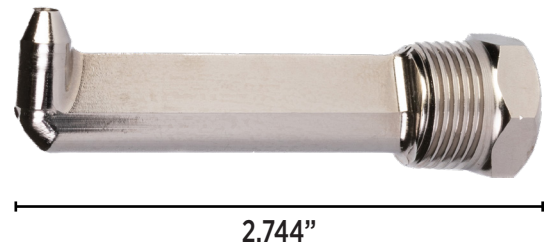

FIRE PUMP FLOW TESTING EQUIPMENT UNIT EX29051 THE RIPTIDE FLOW TESTING SYSTEM ALX

AS TO FLOW MEASUREMENT ACCURACY SPECIFIED BY THE MANUFACTURER WHEN INSTALLED IN ACCORDANCE WITH THE MANUFACTURERS INSTALLATION INSTRUCTIONS



RIPTIDE



(503) 482-8999 | WWW.HYDRA-TAP.COM | CUSTOMERSERVICE@HYDRA-TAP.COM