

FIRE SPRINKLER HEAD GUARDS



FOR PROTECTION OF SPRINKLER HEADS IN INDUSTRIAL APPLICATIONS
(storage racks, low drops, etc.)

ONE PIECE DOUBLE HOOK HEADGUARD

Heavy wire construction with latch hooks, exposed for easy installation

Available with spot welded 4-1/2" baffle plate

- 4530100: 1/2" IPS (Red)
- 4530101: 1/2" IPS (Chrome)
- 4530102: 1/2" IPS (White)
- 4530103: 1/2" IPS w/ baffle Plate
- 4530104: 3/4" IPS (Red)



TWO PIECE UNIVERSAL HEADGUARD



- 4530150: 1/2" IPS (Red)
- 4530150CP: 1/2" IPS (Chrome)
- 4530157: 3/4" IPS (Red)
- 4530153: baffle plate (Red)

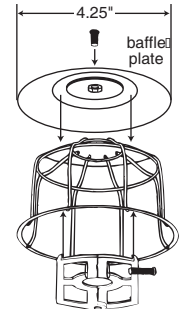
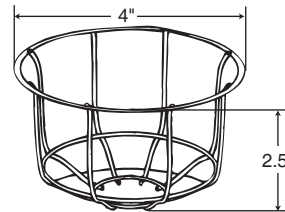

RECESSED HEADGUARD



Item # 4530155
3 1/2" x 3" with 1/2" IPS hole
Chrome Plated Steel Construction
One piece headguard



System No.		Location		Spec Section		Paragraph	
Submitted By		Date		Approved		Date	

SPRINKLER HEAD GUARDS

ONE PIECE DOUBLE HOOK HEADGUARD



FOR PROTECTION OF SPRINKLER HEADS IN INDUSTRIAL APPLICATIONS (storage racks, low drops, etc.)

Heavy wire construction with latch hooks, exposed for easy installation

Available with spot welded 4-1/2" baffle plate

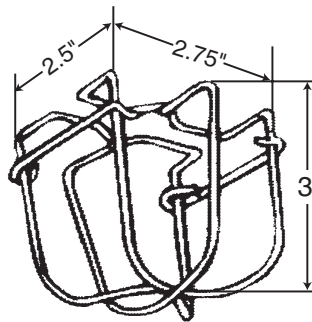
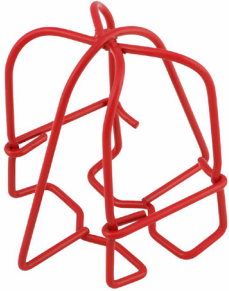

Designed to provide protection against low level impacts to pendent, upright or sidewall sprinkler heads.

Provides additional protection for sprinklers that may experience greater opportunity for repeated abuse.

Caution: Head guards will not protect sprinkler heads from severe abuse or impact.

Finish: Red or White Powder Coated Chrome Plated

- 4530100: 1/2" IPS (Red)
- 4530101: 1/2" IPS (Chrome Plated)
- 4530102: 1/2" IPS (White)
- 4530104: 3/4" IPS
- 4530103: 1/2" IPS with baffle plate (Red)

1 piece Head Guard installation can be accomplished without tools and can be installed in the pendent or upright position.

Unclasp both hooks on either side of the guard.

Spread the cage open just enough to clear the sprinkler head frame and deflector being careful not to damage the sprinkler head.

Engage the open end of the cage at the base of the sprinkler head between the frame and the threads.

Reengage both hooks on either side of the sprinkler head.

System No.		Location	
Submitted By		Date	

Spec Section		Paragraph	
Approved		Date	

SPRINKLER HEAD GUARDS
TWO PIECE UNIVERSAL HEADGUARD



FOR PROTECTION OF SPRINKLER HEADS IN INDUSTRIAL APPLICATIONS (storage racks, low drops, etc.)

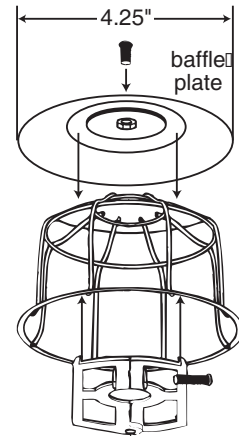
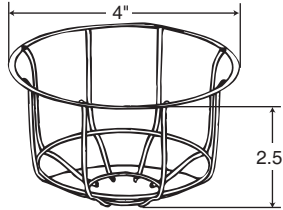
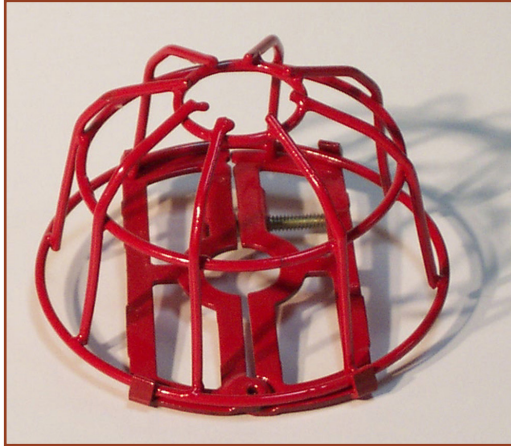

Designed to provide protection against low level impacts to the sprinkler head. Features a cage and clamping base plate. This design can provide additional protection for sprinklers that may experience greater opportunity for repeated abuse. Caution: Head guards will not protect sprinkler heads from severe abuse or impact.

Finish: Red Powder Coated

4530150: 1/2" IPS

4530157: 3/4" IPS

4530153: baffle plate (optional)

Installation requires the use of a flat head screw driver.

Place the base plate around the top thread of the sprinkler head closest to the frame.

Close the base plate around the thread. At the same time, hold the cage to the base plate until the base plate engages the cage with its four tangs.

Adjust the set screw until base plate is firmly attached to the sprinkler.

System No.		Location		Spec Section		Paragraph	
Submitted By		Date		Approved		Date	